

Hello!



Szkoła Podstawowa nr 5 w Łukowie

School year 2021-2022



Headmaster Iwona Kmieć

School office:

tel: 25 798 46 57

e-mail: piatkalukow@wp.pl

Important contacts:

Your class teacher:
..... room number: tel :
..... e-mail:

School counsellor- *a person who supports children at school and to whom you can always turn to:*

Danuta Dybciak room number: e-mail: ..

.....

Your name/surname:

.....

Your class:

.....

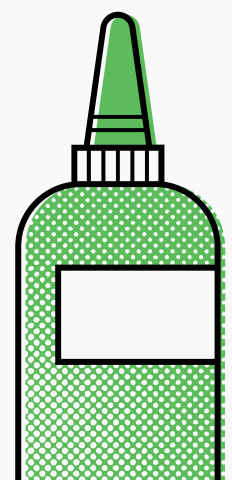
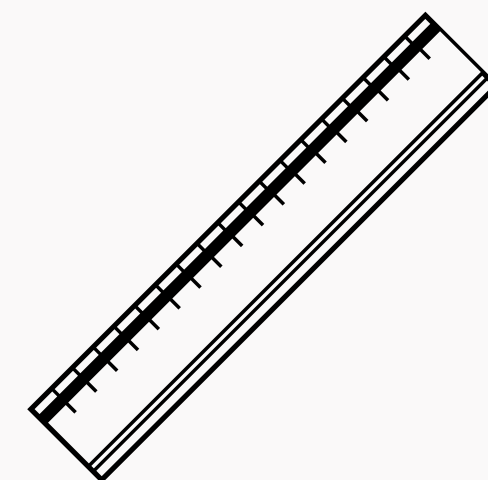
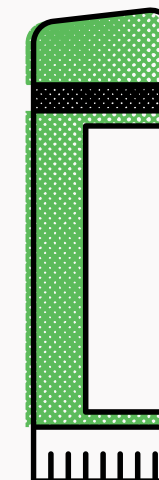
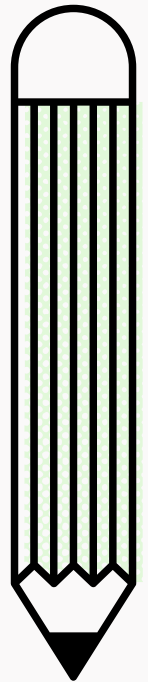
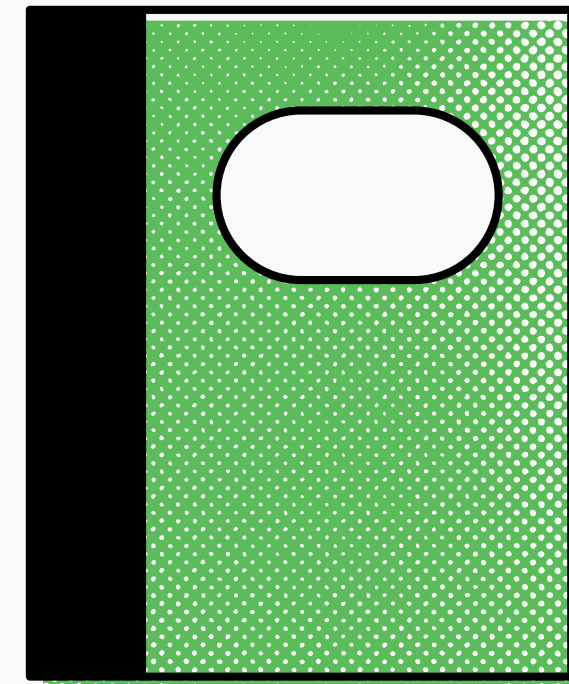
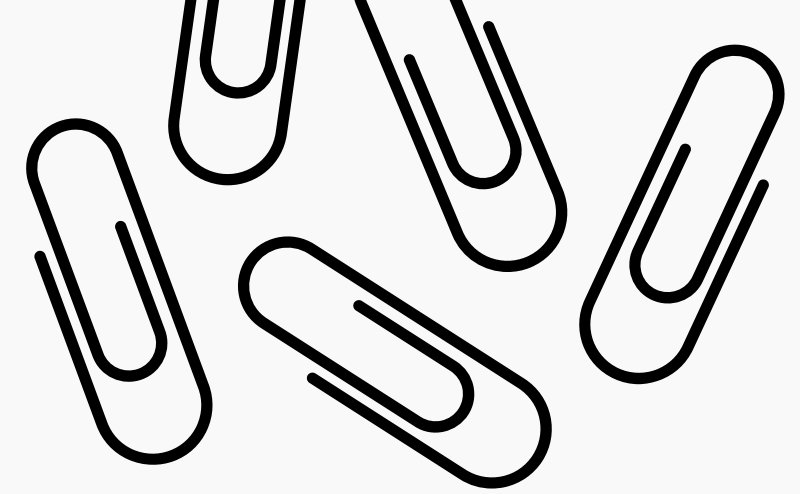

School address:

Szkoła Podstawowa nr 5 im. gen.
Władysława Sikorskiego
ul. Siedlecka 56, 21-400 Łuków

Website
www.sp5lukow.pl



Days free from classes in the 2020/2021 semester II

February 14 - 27, 2022 - winter holidays

April 14-19, 2022 - spring break

1- 3 May 2022 - May holidays

May 24-26, 2022 - headmaster's day

June 5, 2022 - Pentecost

June 16, 2022 - Corpus Christi

June 17, 2022 - headmaster's day

June 21, 2022 - end of the school year



Electronic diary

VULCAN log - an electronic student diary, in which you can quickly check grades, attendance or announced tests. The mobile version is available for free

<https://uonetplus.vulcan.net.pl/lukow/>

VULCAN
E-DZIENNIK

Zaloguj się >

School breaks

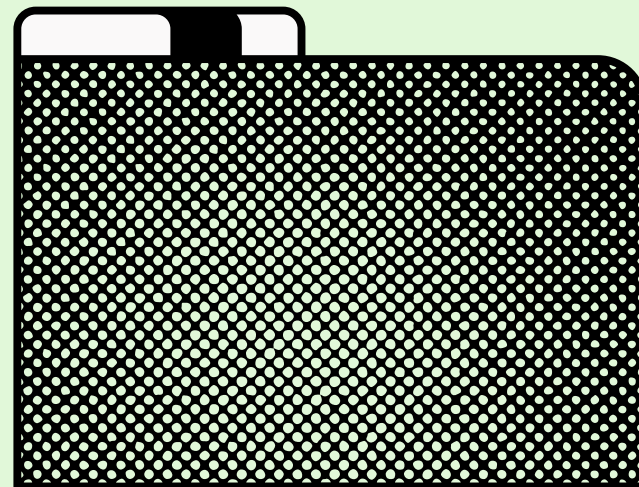
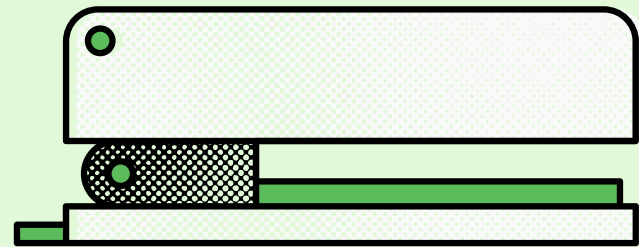
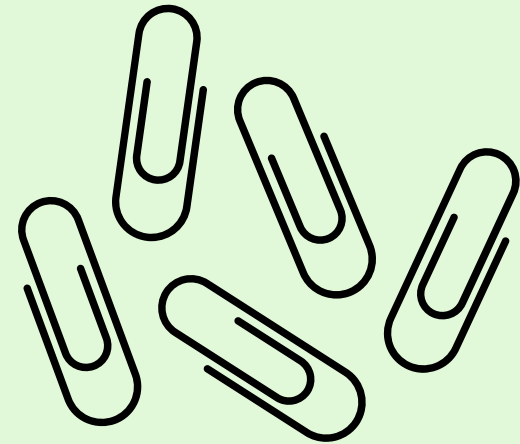
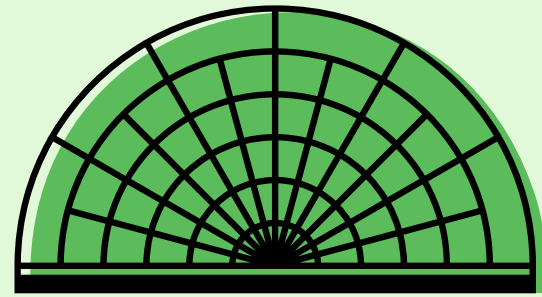

1. 8:00 – 8:45
2. 8:50 – 9:35
3. 9:40 – 10:25
4. 10:35 – 11:20
5. 11:25 – 12:10
6. 12:25 – 13:10
7. 13:25 – 14:10
8. 14:15 – 15:00
9. 15:05 – 15:50

School stuff

Parent / Guardian!

Remember to provide your child with a lunch.

Ask the class teacher about availability and the possibility of exemption from fees.

textbooks

workbooks

**swimming
outfit**

**second
breakfast**

lunch card

change shoes

pen, pencil, crayons, scissors, glue

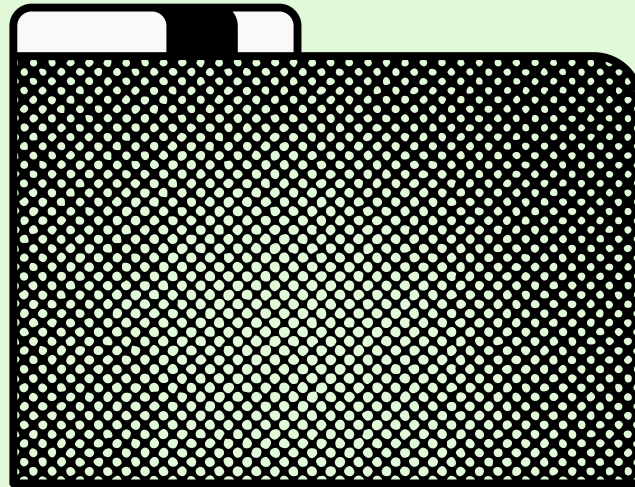
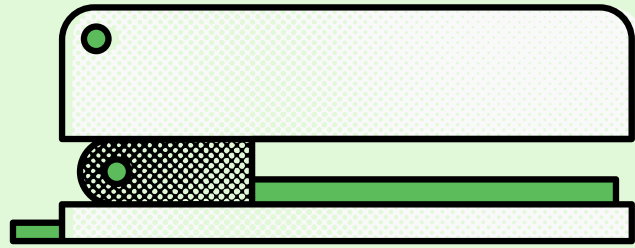
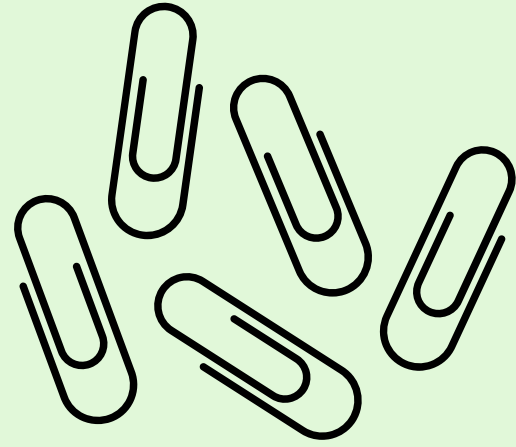
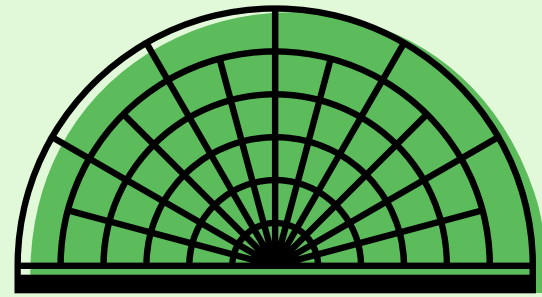

WHAT DO I DO IF ...

I HAVE BEEN ABSENT / ABSENT IN LESSONS

I bring a justification from the parent, guardian or doctor and show it to the tutor or to the supervising teacher or my parent / guardian justifies me in the Electronic Journal.

I AM LATE

I go to my class and say, "Sorry I'm late."

I FEEL BAD

I am talking to the class teacher or homeroom nurse or school nurse. They will notify my parent or guardian who will pick me up from school.

I FEEL LOST, I CANNOT APPLY IN A NEW ENVIRONMENT

I talk to a teacher / school teacher or my class teacher.

I have argued / argued with a friend / colleague from school

I talk to a supervising teacher/school counsellor/teacher

I CANNOT DO THE HOUSE TASK BY myself

I talk to a tutor, teachers or educator / school pedagogue.

I WANT TO BE ACTIVE

I ask the form teacher / educator about school volunteering groups or other forms of activity.

The grading system in our school

class

You and your parents / guardians receive up-to-date information about your progress in learning and behavior. At the end of each semester and school year, you receive a descriptive grade.

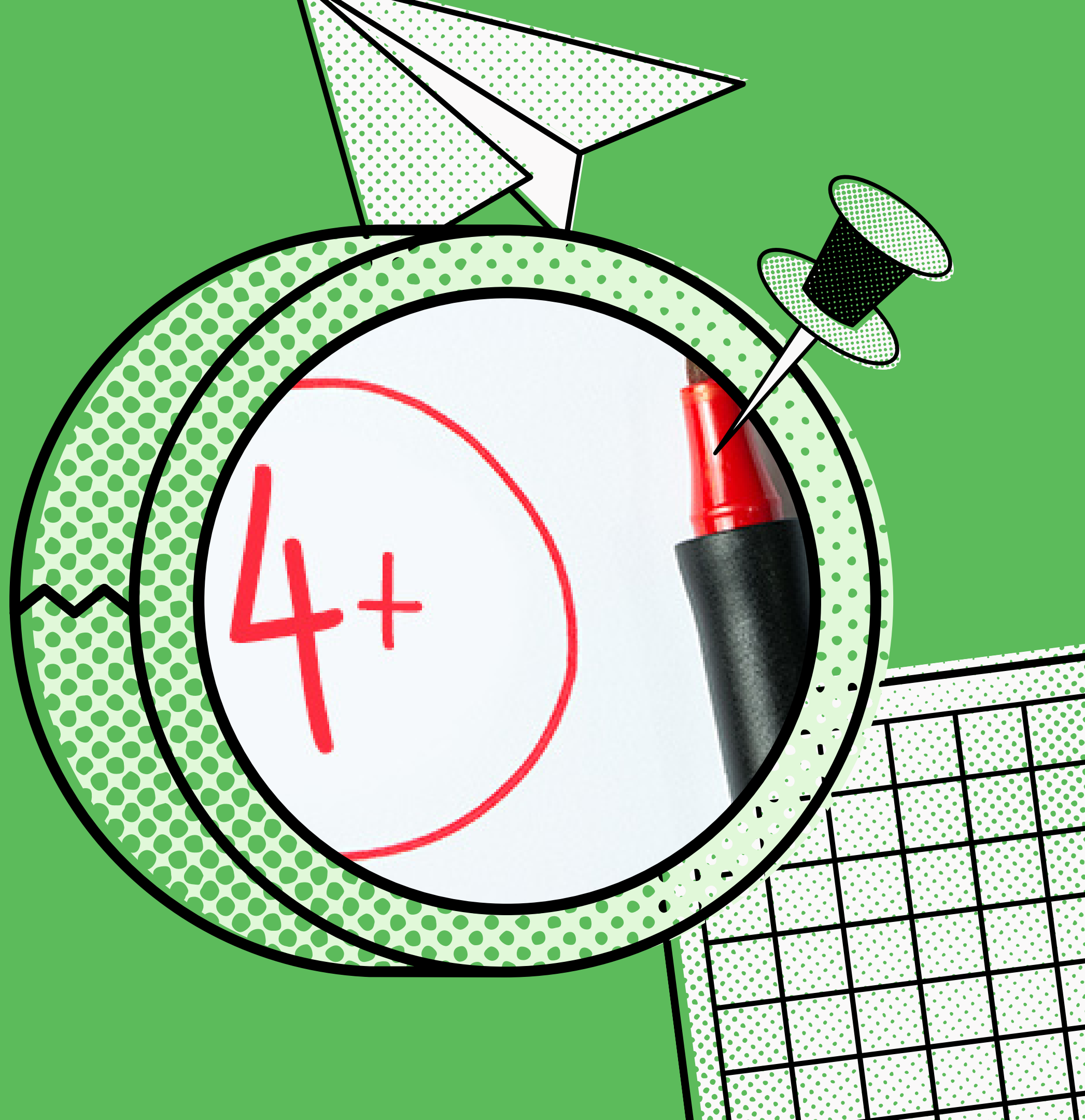

class IV-VIII

You are given grades on a scale of 1-6.

Teachers assess your learning progress on an ongoing basis.

At the end of each semester and year, your teachers will give you a final grade for each subject and behavior.

Subject assessment on a scale of 1-6

6 - excellent (++++++)

5 - very good (+++++)

4 - good (++++)

3 - satisfactory (++++)

2 - permissive (++)

1 - insufficient (-)

Your behavior will be assessed as:

Exemplary, very good, good, correct, inappropriate, reprehensible



Alarm phones:

- Ambulance Service - 999 or 112
- Police - 997 or 112
- Fire Department - 998 or 112

